

PRO 1100

In-Building Cell Signal Amplifier



Installation Guide

NEED HELP?

 wilsonpro.com

 866.294.1660

Index

Package Contents	1
About The Pro 1100	2
Key Features	4
Post Install Setup	5
Menu System	7
Safety Guidelines	12
Warranty	17

Package Contents

Kit 460147 50Ω



Pro 1100



Wide Band Directional
Antenna + 75'
Wilson 400 Cable



Dome Antenna +
60' Wilson 400 Cable



2' Wilson
400



Lightning Surge
Protector

Kit 461147 75Ω



Pro 1100



Wide Band Directional
Antenna + 75'
RG11 Cable



Dome Antenna +
50' RG11 Cable



2' Wilson
RG11



Lightning Surge
Protector



Pro 1100

In-Building Cell Signal Amplifier



Up to +25 dBm uplink power for maintaining connections with far-away cell towers



Up to +15 dBm downlink power for improved indoor cell coverage area

XDR
TECHNOLOGY

eXtended Dynamic Range (XDR)
for Continuous Connectivity



Color touch screen, for easy installation and displaying detailed amplifier status



The Pro 1100 cell signal amplifier system provides significantly enhanced 4G LTE and 3G voice and data coverage inside large homes and commercial buildings where cell signals may not otherwise penetrate. Installation of a Pro 1100 cell signal amplifier system results in fewer dropped calls, improved voice quality, uninterrupted texts, and faster data speeds—along with better audio and video streaming. The Pro 1100 has been approved for use by the FCC (U.S), ISED (Canada), and is carrier-accepted by all major mobile networks and providers in North America. No additional approvals or permissions are required.



The Pro 1100 also incorporates Wilson Electronics' state-of-the-art XDR (eXtended Dynamic Range) technology that prevents signal overload conditions which can, in accordance with regulations, force the amplifier to shut down. When the Pro 1100 senses that any incoming cell signal is too strong and threatens to overload the system, XDR automatically reduces amplifier gain to compensate while maintaining signal coverage throughout the building. The Pro 1100 incorporates an easy-to-use color LCD touch screen, and both antenna ports are located on the top of the unit for simple installation. Like all WilsonPro cell signal boosters, the Pro 1100 amplifier system is universal: it works for all cellular devices, all services and all U.S. and Canada cell phone carriers.

Key Features



Extended Dynamic Range (XDR) for continuous connectivity: XDR lets the Pro 1100 system work with an incoming signal and never shuts down due to a strong outside signal.



Simple Wall-Mount Installation: An indoor and outdoor port are located on top of the amplifier for easy antenna connections, while an exposed mounting flange at each corner of the amplifier provides for simple and clean wall-mount installation.



Onboard Software for Better Control: The amplifier is automatically controlled with automatic onboard software, ensuring great connectivity throughout large spaces and multi-story buildings. The amplifier will adjust its gain level up or down as required by the conditions of the immediate signal environment.



Color LCD Touch Screen: The Pro 1100 utilizes a color LCD touch screen, for assessing amplifier performance, making adjustments to the outside antenna, and turning bands on and off.

Post Install Setup

The Pro 1100 is designed with advanced internal programming, which allows it to automatically adjust for a variety of conditions, while still amplifying weak signals.

Once the antenna cables are connected, turn the unit on by connecting the power supply cord, at the bottom.



Installation Diagram

A Wilson Lightning Surge Protector is recommended for all building installations. Make sure the protector is installed outside the building. Connect it to suitable ground and in line, between the Outside Antenna and the Signal Amplifier.

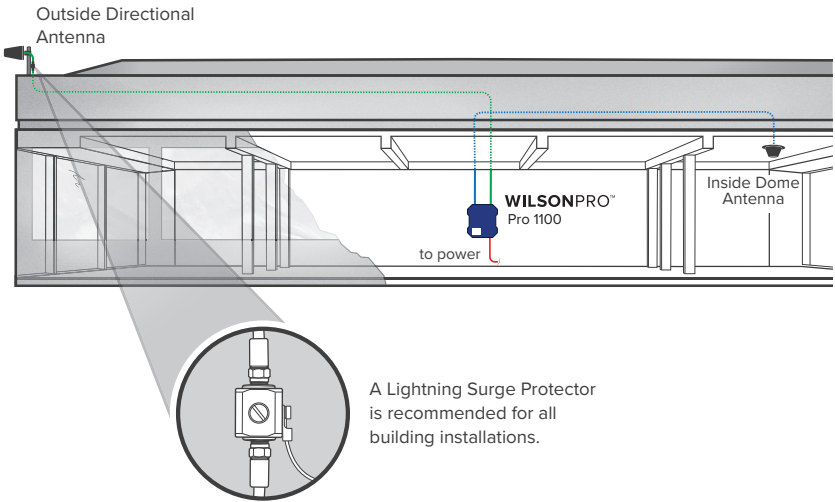

Menu System

The Pro 1100 takes about 5 seconds to boot up. Once boot up is complete, the home screen will appear, showing the amplification and status of each port and band.



Start Up Screen

Home Screen

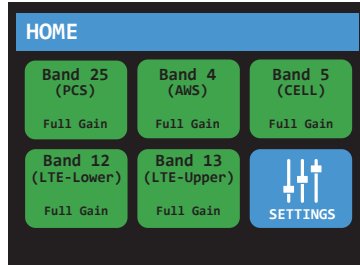

Band Menu Color Description



A solid green light indicates that a band is operating correctly with maximum allowable gain.



A solid yellow light indicates band gain reduction because of an oscillation condition. Reposition antennas (increase separation between indoor and outdoor antennas, and point in opposite directions) and then reboot (turn the unit off & on) the Pro 1100 to reactivate the band and maximize performance. When adequate separation is achieved, the yellow lights will return to green upon reboot.

Note: when the light is yellow, the band is operational; however, performance is reduced.

(MENU SYSTEM cont.)



A red light indicates a band has been shut down because of a severe oscillation condition or repeated oscillation. Reposition antennas (increase separation between indoor and outdoor antennas, and point in opposite directions) and then reboot (turn the unit off & on) the Pro 1100 to reactivate the band and maximize performance. When adequate separation is achieved, the red light(s) will return to green upon reboot.



Gray indicates band has been disabled.

Settings Screen

Tap icon to view the **Settings Screen**.

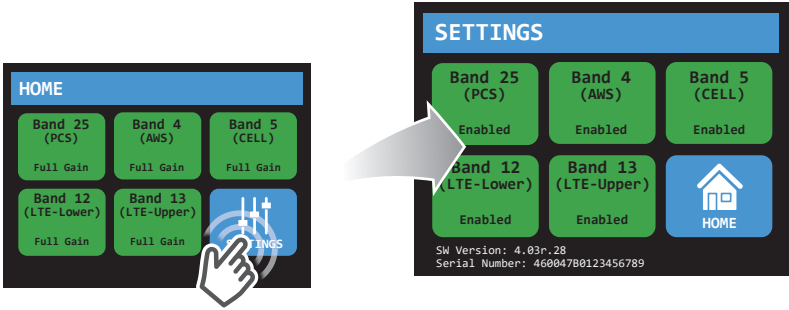

Bands can be disabled/enabled by tapping the desired band. Note: disabling a cell band is not recommended. Bands should only be disabled by expert installers.

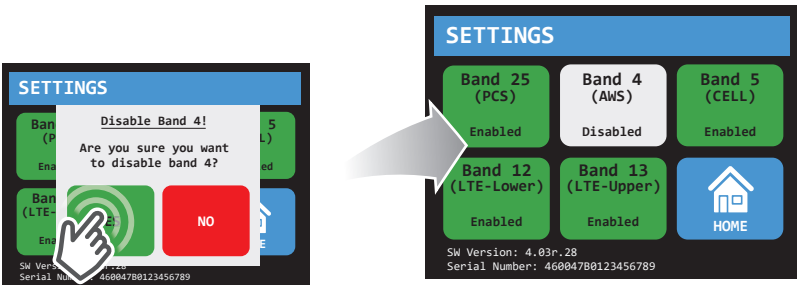
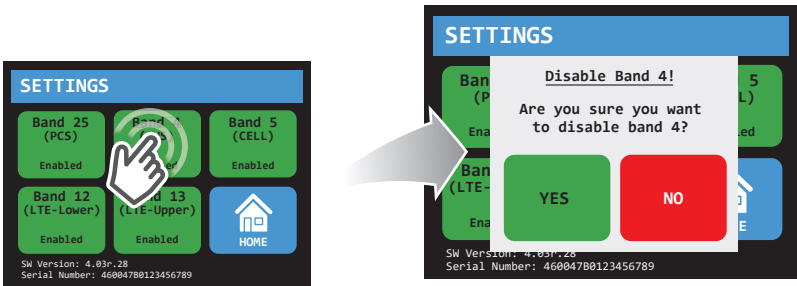

(MENU SYSTEM - SETTINGS SCREEN cont.)

To go back to the home screen tap on the **home icon**.

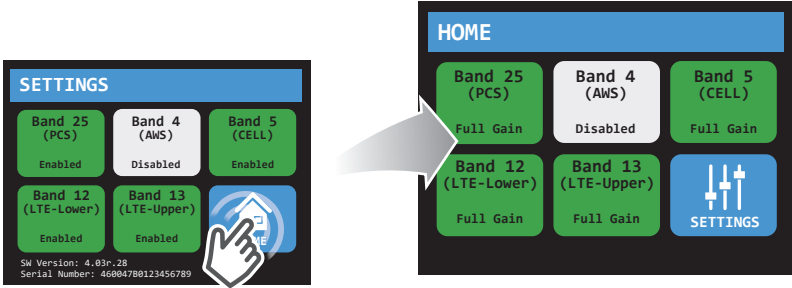

To view specific band information (such as the strength of the received uplink & downlink signal, status details and the amplifier gain) tap desired band on the home screen.

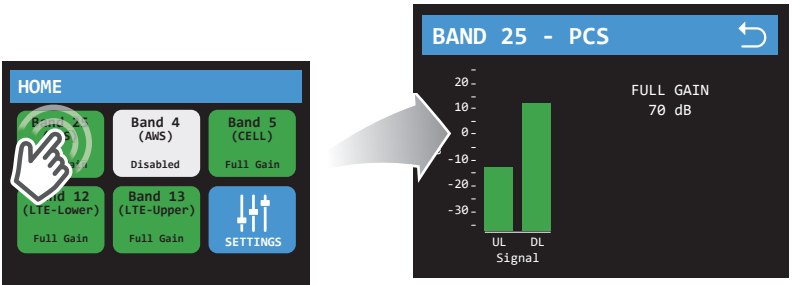

Note: The direction of the outside antenna should be adjusted until the “DL” bar is maximized.

(MENU SYSTEM - SETTINGS SCREEN cont.)

By tapping on the desired Band, a more detailed screen will appear for better troubleshooting.

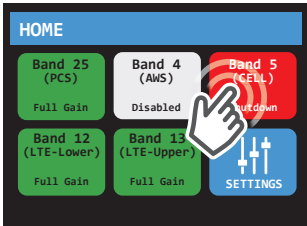
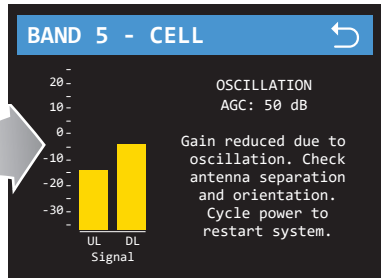
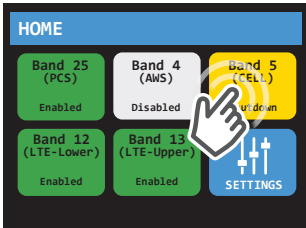

BAND 5 - CELL

OSCILLATION SHUTDOWN

Check antenna separation and orientation. Cycle power to restart system.

For additional assistance, contact WilsonPro technical support.
US & Canada 866-294-1660

Safety Guidelines

Warnings

To uphold compliance with network protection standards, all active cellular devices must maintain at least 6 feet of separation distance from Panel and Dome antennas.

Use only the power supply provided in this package. Use of a non-Wilson Electronics product may damage your equipment.

The Signal Amplifier unit is designed for use in an indoor, temperature-controlled environment (operating temperature ranges from -40°C to 60°C – -40°F to 140°F). It is not intended for use in attics or similar locations subject to temperatures in excess of that range.

RF Safety Warning: Any antenna used with this device must be located at least 8 inches from all persons.

AWS Warning: The Outside Antenna must be installed no higher than 10 meters (31'9") above ground.

This is a CONSUMER device.

BEFORE USE, you **MUST REGISTER THIS DEVICE** with your wireless provider and have your provider's consent. Most wireless providers consent to the use of signal boosters. Some providers may not consent to the use of this device on their network. If you are unsure, contact your provider.

You **MUST** operate this device with approved antennas and cables as specified by the manufacturer. Antennas **MUST** be installed at least 20 cm (8 inches) from any person.

You **MUST** cease operating this device immediately if requested by the FCC or licensed wireless service provider.

WARNING. E911 location information may not be provided or may be inaccurate for calls served by using this device.

This device may operate in a fixed location only, for in-building use.

FOR MORE INFORMATION ON REGISTERING YOUR SIGNAL AMPLIFIER WITH YOUR WIRELESS PROVIDER, PLEASE SEE BELOW:

Sprint: http://www.sprint.com/legal/fcc_boosters.html

T-Mobile/MetroPCS: <https://support.t-mobile.com/docs/DOC-9827>

Verizon Wireless: <http://www.verizonwireless.com/wcms/consumer/register-signal-booster.html>

AT&T: <https://securec45.securewebsession.com/attsignalbooster.com/>

U.S. Cellular: <http://www.uscellular.com/uscellular/support/fcc-booster-registration.jsp>

Antenna Kit Options

The following accessories are certified by the FCC to be used with the **PRO 1100**.

OUTSIDE FIXED

Kit 314411-40075

Wide Band Directional Antenna
With 75' Wilson 400

Kit 314411-5825

Wide Band Directional Antenna
With 25' RG-58

Kit 304422-1120

Omni Enterprise 304422 With
20' RG-11

Kit 301111-5850

Yagi Antenna 301111 With 50' RG-58

Kit 311203-40020

Omni Directional Antenna (311203)
With 20' Wilson 400

Kit 314453-5825

Panel Antenna With 25' RG-58

Kit 311203-5820

Omni Directional Antenna (311203)
With 20' RG-58

Kit 301111-11140

Yagi 301111 With 140' RG-11

Kit 311201-1120

Omni Directional Antenna 311201
With 20' RG-11

Kit 314453-40075

Panel Antenna With 75' Wilson 400

Kit 311141-1120

Grey Panel With 20' RG-11

Kit 314473-1175

Wide Band Directional Antenna
With 75' RG-11

Kit 314475-1175

Wide Band Directional Antenna
With 75' RG-11

Kit 301111-400170

Yagi Antenna 301111 With 170'
Wilson 400

Kit 304421-17410

Omni Consumer 304421 With
10' RG-174

Kit 304421-5810

Omni Consumer 304421 With
10' RG-58

Kit 304422-40020

Omni Enterprise 304422 With
20' Wilson 400

INSIDE FIXED

Kit 304412-40060

Dome w/60' Wilson 400

Kit 304419-1150

Dome w/50' RG-11

Specifications

Model Number	460047 / 461047				
FCC ID	PWO460047				
IC ID	4726A-460047				
Connectors	N-Female / F-Female				
Antenna Impedance	50 Ohms / 75 Ohms				
Frequency	698-716 MHz, 729-746 MHz, 777-787 MHz, 824-894 MHz, 1850-1995 MHz, 1710-1755/2110-2155 MHz				
Power output for single cell phone (Uplink) dBm	700MHz Band12/17	700MHz Band13	800MHz	1700MHz	1900MHz
	24.0	24.0	25.0	25.0	25.0
Power output for single cell phone (Downlink) dBm	700MHz Band12/17	700MHz Band13	800MHz	2100MHz	1900MHz
	15.1	15.1	15.3	15.2	15.2
Noise Figure	5 dB nominal				
Isolation	> 90 dB				
Power Requirements	120V AC 0.5A				

Each Signal Booster is individually tested and factory set to ensure FCC compliance. The Signal Booster cannot be adjusted without factory reprogramming or disabling the hardware. The Signal Booster will amplify, but not alter incoming and outgoing signals in order to increase coverage of authorized frequency bands only. If the Signal Booster is not in use for five minutes, it will reduce gain until a signal is detected. If a detected signal is too high in a frequency band, or if the Signal Booster detects an oscillation, the Signal Booster will automatically turn the power off on that band. For a detected oscillation the Signal Booster will automatically resume normal operation after a minimum of 1 minute. After 5 (five) such automatic restarts, any problematic bands are permanently shut off until the Signal Booster has been manually restarted by momentarily removing power from the Signal Booster. Noise power, gain, and linearity are maintained by the Signal Booster's microprocessor.

This device complies with Part 15 of FCC rules. Operation is subject to two conditions: (1) This device may not cause harmful interference, and (2) this device must accept any interference received, including interference that may cause undesired operation. Changes or modifications not expressly approved by weBoost could void the authority to operate this equipment.

Notes

NEED HELP?

 support.wilsonpro.com

 866.294.1660

Warranty

✓ 30 DAY MONEY-BACK GUARANTEE

All WilsonPro products are protected by WilsonPro 30-day money-back guarantee. If for any reason the performance of any product is not acceptable, simply return the product directly to the reseller with a dated proof of purchase.

✓ 3 YEAR WARRANTY

WilsonPro Amplifiers are warranted for three (3) years against defects in workmanship and/or materials. Warranty cases may be resolved by returning the product directly to the reseller with a dated proof of purchase.

Signal Amplifiers may also be returned directly to the manufacturer at the consumer's expense, with a dated proof of purchase and a Returned Material Authorization (RMA) number supplied by WilsonPro. WilsonPro shall, at its option, either repair or replace the product.

This warranty does not apply to any Signal Amplifiers determined by WilsonPro to have been subjected to misuse, abuse, neglect, or mishandling that alters or damages physical or electronic properties.

Replacement products may include refurbished WilsonPro products that have been recertified to conform with product specifications.

RMA numbers may be obtained by contacting Customer Support.

DISCLAIMER: The information provided by WilsonPro is believed to be complete and accurate. However, no responsibility is assumed by WilsonPro for any business or personal losses arising from its use, or for any infringements of patents or other rights of third parties that may result from its use.

MARKETING APPROVAL: Installer and end customer hereby grants to Wilson Electronics the express right to use installers or end customers company logo in marketing, sales, financial, and public relations materials and other communications solely to identify Customer as a Wilson Electronics customer.



3301 East Deseret Drive, St. George, UT
www.wilsonpro.com | support.wilsonpro.com

Copyright © 2017 Wilson Electronics. All rights reserved.
Wilson Electronics products covered by U.S. patent(s) and pending application(s)
For patents go to: weboost.com/us/patents