

Home Inside Antenna Standard

SKU: 314444

MSRP: \$99.99

FEATURES

- Works on all worldwide cellular bands for voice and data: LTE/CDMA/GSM/UMTS/AWS
- High performance for cellular repeater-boosters
- High gain signal output
- Boost 698-960 & 1710-2700 MHz cellular frequencies
- Designed for building interior installation
- High efficiency and compact design
- Boosts voice and data
- Simple install kit with wall mount bracket and desk stand
- 2-year warranty

⚠️ WARNING: This product can expose you to chemicals including Nickel, which is known to the State of California to cause cancer, and Bisphenol A, which is known to the State of California to cause birth defects or other reproductive harm. For more information go to www.P65Warnings.ca.gov

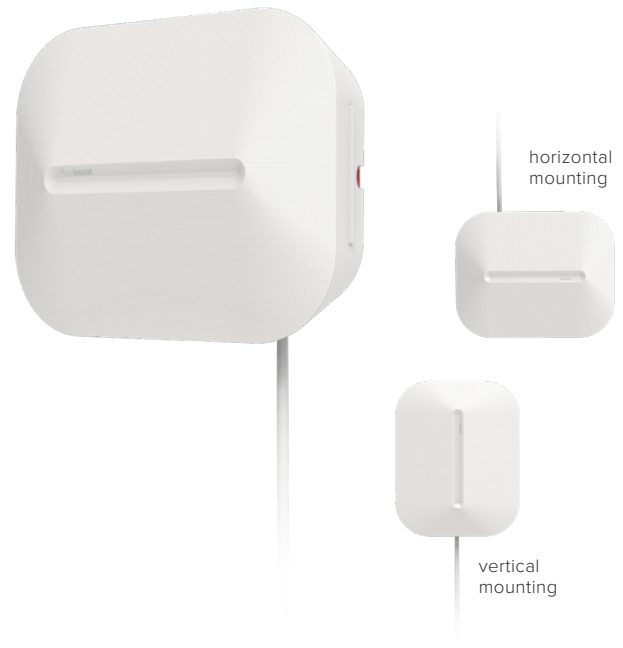

Kit Includes



Specifications

ELECTRICAL

Frequency Band (MHz)	698-806	806-960	1710-1880	1900-2200	2200-2700
Peak Gain (dBi)	5.75	6	7.3	7.33	7.62
Efficiency (%)	65.80	63.34	66.77	55.19	55.17
VSWR	<1.5:1		<1.5:1		
Polarization	Horizontal				
Half-Power Azimuth Beamwidth (°)	79	72	56	51	55
Half-Power Elevation Beamwidth (°)	87	89	86	75	48
Front-to-Back Ratio (dB)	>10		>17	>15	>12
Impedance (Ω)	75				
Maximum Power (W)	50				

MECHANICAL

Model	314444
Connector	F- Female
Dimensions (in/mm)	8.875x7.125x2.625 / 225.4x180.9x66.6
Shipping Dimensions (in/mm)	11.5x7.83x3.5 / 292.1x198.8x88.9
Antenna weight (lb/kg)	1.75 / .79
Packing weight (lb/kg)	1.6 / .72
Radiator Material	PCB & Aluminum
Radome Material	Plastic-ChiMei PC385

Radiation Patterns, 700-960 MHz

700 MHz 800 MHz 900 MHz 960 MHz

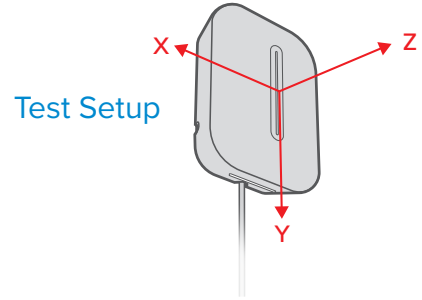

XY Plane

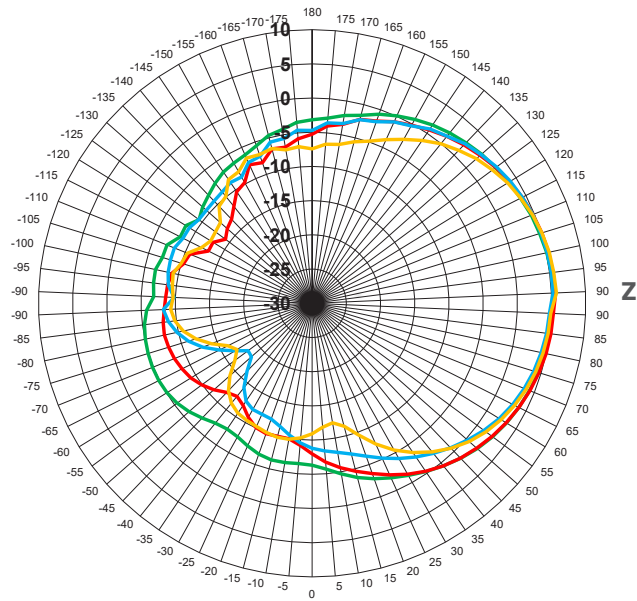

YZ Plane

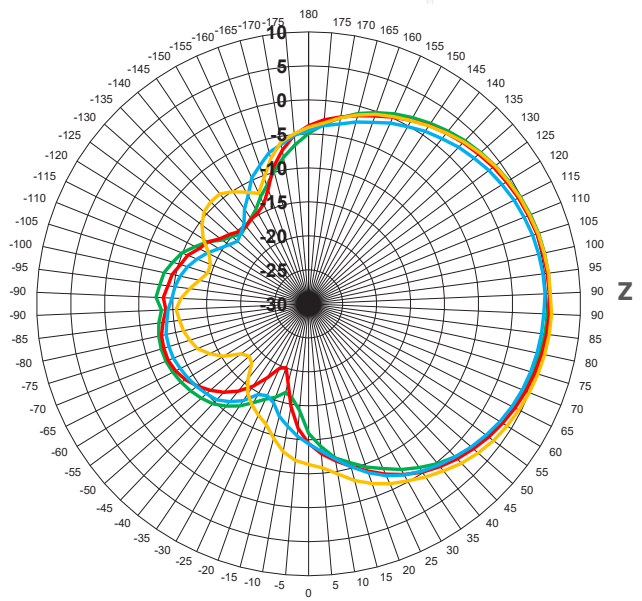

Radiation Patterns, 1700-2200 MHz

1700 MHz 1900 MHz 2100 MHz 2200 MHz

XY Plane

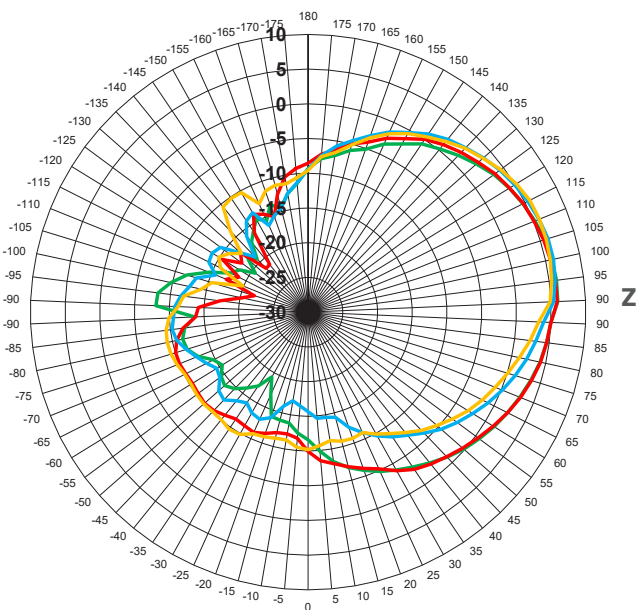

YZ Plane

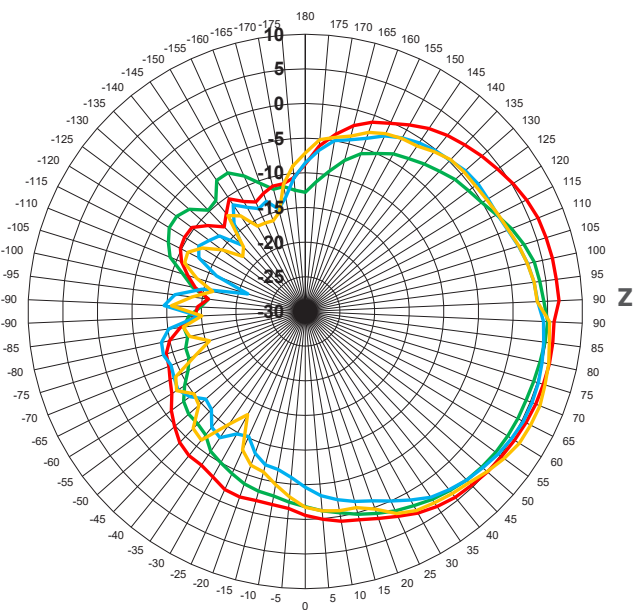

Radiation Patterns, 2300-2700 MHz

2300 MHz 2500 MHz 2600 MHz 2700 MHz

XY Plane

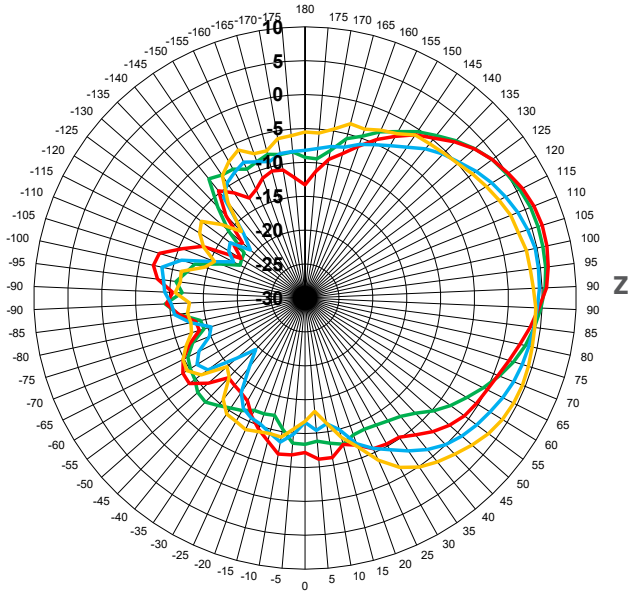

YZ Plane

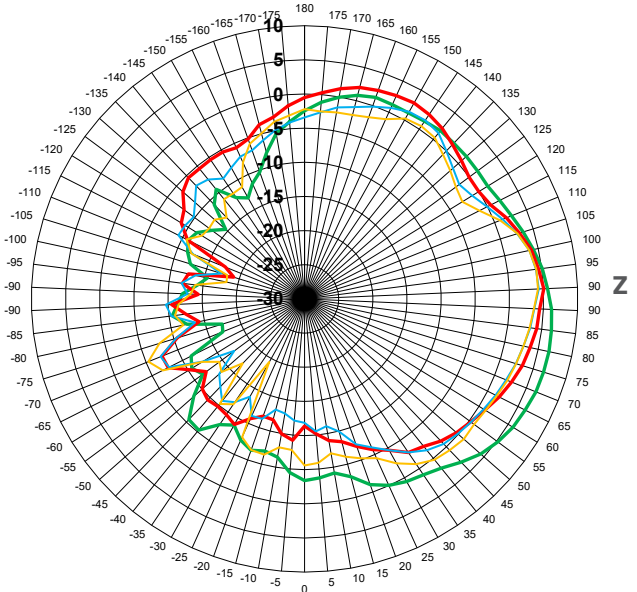

Peak Gain

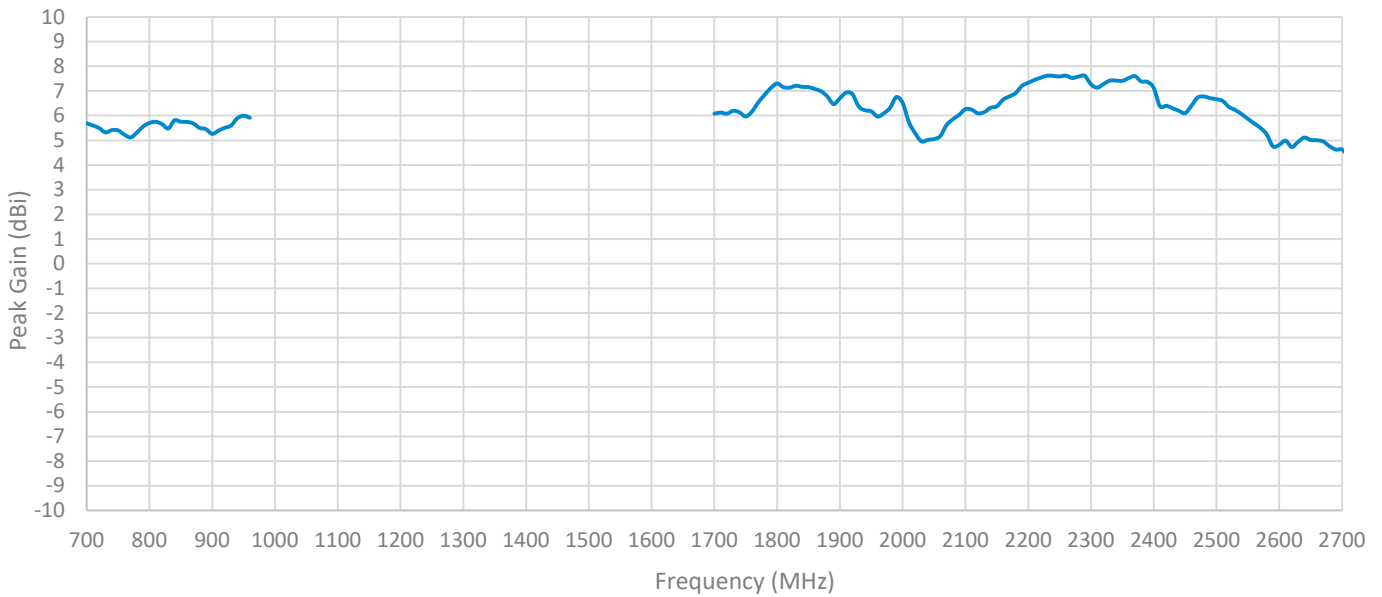

Efficiency

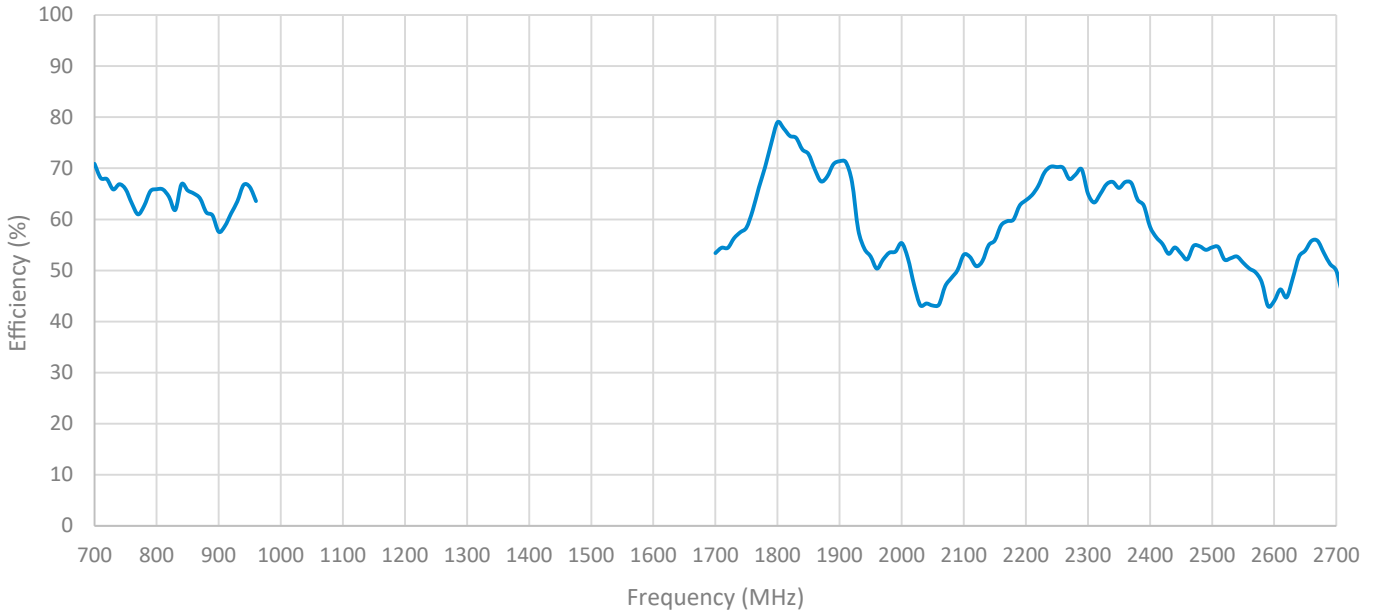

Package Dimensions

11.5 L x 7.675 W x 3.5 H

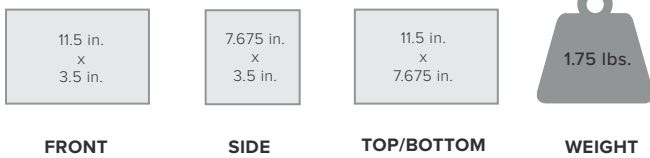

MASTER CARTON: 25 L x 18 W x 15 H | 31.74 lbs. | QTY:18



Support

 2 Year Warranty

Email: support@wilsonelectronics.com

Website: <http://support.weboost.com>

Phone: +1 866 294 1660 Monday to Saturday

* **WARNING:** Cancer and Reproductive Harm - www.P65Warnings.ca.gov.

ASSEMBLED IN THE USA



UPC

